

Selection diagram

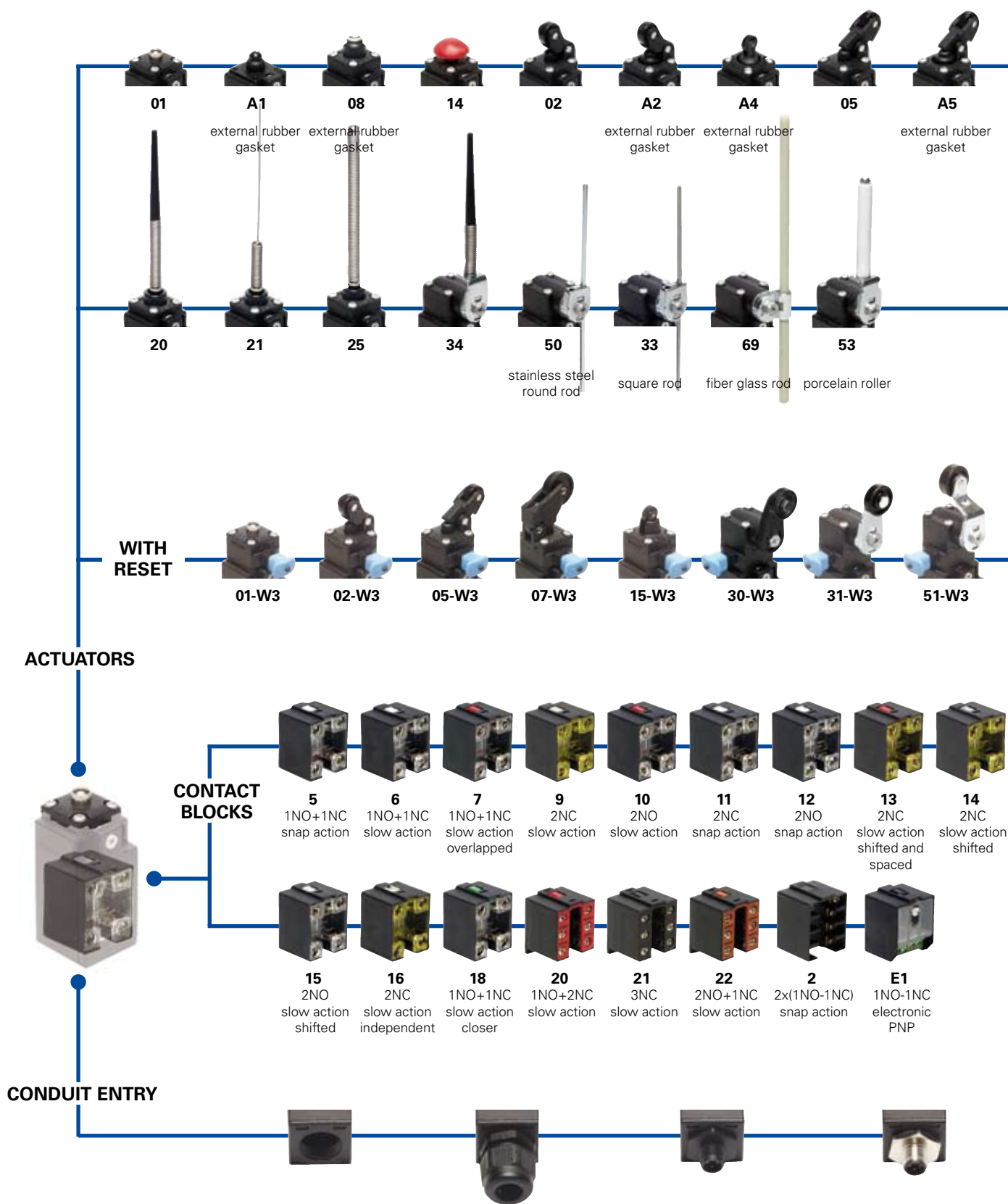

Threaded conduit entry	
A	PG 13,5 (standard)
M1	PG 11
M2	M16x1,5
	M20x1,5

With assembled cable gland	
M20x1,5 PG 13,5	K21 for Ø 6 to Ø 12 mm cables range
	K25 for Ø 3 to Ø 7 mm cables range
	K23 for Ø 6 to Ø 12 mm cables range
	K27 for Ø 3 to Ø 7 mm cables range

With M12 plastic connector assembled and wired	
K70	4 poles from bottom
K45	8 poles from bottom

With M12 metal connector assembled and wired	
K40	8 poles from bottom
K60	4 poles from bottom

● product option
 → accessory sold separately

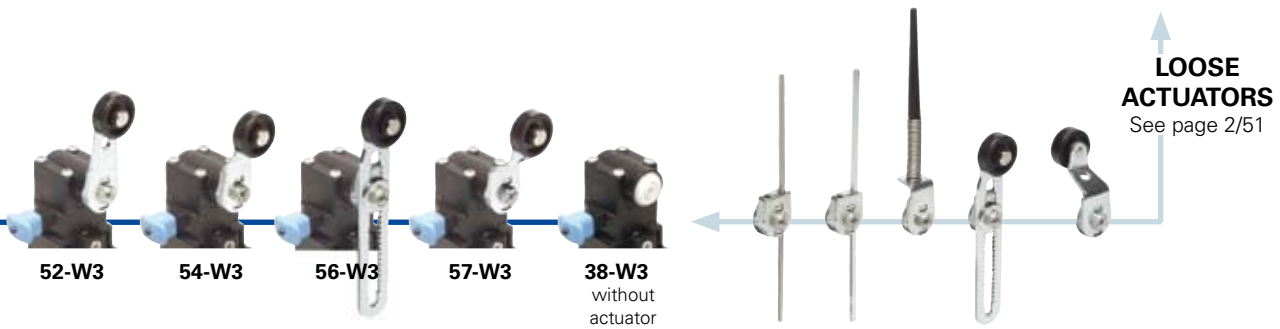
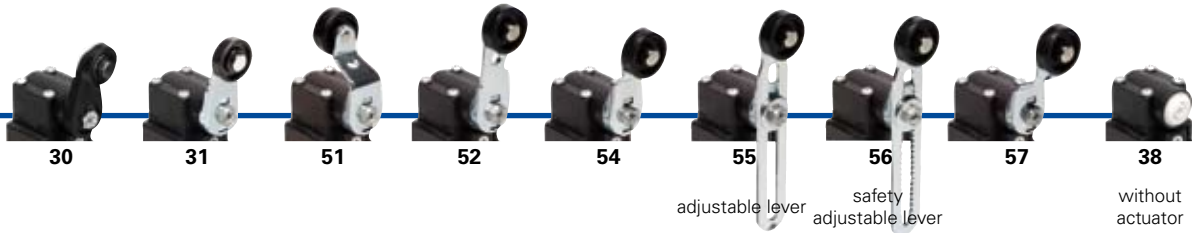

Code structure

Attention! The feasibility of a code number does not mean the effective availability of a product. Please contact our sales office.

article options
FR 502-1W3XGM2K70

Housing	
FR	polymer housing, one conduit entry
Contact blocks	
5	1NO+1NC, snap action
6	1NO+1NC, slow action
7	1NO+1NC, slow action overlapped
...
Actuators	
01	short plunger
02	roller lever
05	offset roller lever
...
Suffix	
	no suffix (standard)
1	with stainless steel roller: - Ø 12 mm for actuators A2, 02, A5, 05 - Ø 14 mm for actuators A2, 02, A5, 05 - Ø 20 mm for actuators 30, 31, 51, 52, 54, 55, 56, 57
2	with Ø 35 mm polymer roller (see special loose actuators on page 2/52)
3	with Ø 50 mm rubber roller (see special loose actuators on page 2/52)
4	with Ø 50 mm overhanging rubber roller (see special loose actuators on page 2/52)

Preinstalled cable gland or connectors	
	no cable gland or connector (standard)
K21	with assembled cable gland suitable for Ø 6 to Ø 12 mm cables range
...
K70	with 4 poles M12 plastic connector
...

For the complete list of all combinations, please contact our technical office.

Threaded conduit entry	
	PG 13,5 (standard)
A	PG 11
M1	M16x1,5
M2	M20x1,5

Contacts type	
	silver contacts (standard)
G	silver contacts gold plated 1 µm (contact block 2 excluded)

External metallic parts	
	zinc plated steel (standard)
X	stainless steel





Reset hooking	
	without reset (standard)
W3	normal reset hooking



Main data

- Polymer housing, one conduit entry
- Protection degree IP67
- 17 contact blocks available
- 48 actuators available
- External stainless steel parts versions
- M12 assembled connector versions
- Silver contacts gold plated versions

Markings and quality marks:

Approval IMQ: EG610
 Approval UL: E131787
 Approval CCC: 2007010305230013
 Approval ECU: 1010151

Technical data

Housing

Made of glass-reinforced polymer, self-extinguishing, shock-proof thermoplastic resin and with double insulation 
 One threaded conduit entry
 Protection degree: IP67 according to EN 60529

General data

Ambient temperature: from -25°C to +80°C
 Version for operation in ambient temperature from -40°C to +80°C on request
 Max actuation frequency: 3600 operations cycles¹/hour
 Mechanical endurance: 20 million operations cycles¹
 Assembling position: any
 Driving torque for installation: see pages 7/1-7/10
 (1) One operation cycle means two movements, one to close and one to open contacts, as foreseen by EN 60947-5-1 standard.

Cross section of the conductors (flexible copper wire)

Contact blocks 20, 21, 22, 33, 34:	min.	1 x 0,34 mm ²	(1 x AWG 22)
	max.	2 x 1,5 mm ²	(2 x AWG 16)
Contact blocks 5, 6, 7, 9, 10, 11, 12, 13, 14, 15, 16, 18:	min.	1 x 0,5 mm ²	(1 x AWG 20)
	max.	2 x 2,5 mm ²	(2 x AWG 14)
Contact block 2:	min.	1 x 0,5 mm ²	(1 x AWG 20)
	max.	2 x 1,5 mm ²	(2 x AWG 16)

In conformity with standards:

IEC 60947-5-1, EN 60947-5-1, EN 60947-1, EN 50047, IEC 60204-1, EN 60204-1, EN 1088, EN ISO 12100-1, EN ISO 12100-2, IEC 60529, EN 60529, NFC 63-140, VDE 0660-200, VDE 0113.

Approvals:

IEC 60947-5-1, UL 508, GB14048.5-2001.

In conformity with requirements requested by:

Low Voltage Directive 2006/95/EC, Machinery Directive 2006/42/EC and Electromagnetic Compatibility 2004/108/EC.

Positive contact opening in conformity with standards:

IEC 60947-5-1, EN 60947-5-1, VDE 0660-206.

Installation for safety applications:

Use only switches marked with the symbol . The safety circuit must always be connected with the **NC contacts** (normally closed contacts: 11-12, 21-22 or 31-32) as stated in the **standard EN 60947-5-1, encl. K, par. 2**. The switch must be actuated with **at least up to the positive opening travel** shown in the travels diagrams on page 7/6. The switch must be actuated **at least with the positive opening force**, shown in brackets, underneath each article, near the value of the min. force.

⚠ If not expressly indicated in this chapter, for the right installation and the correct utilization of all articles see requirements indicated from page 7/1 to page 7/10.

	Electrical data	Utilization categories	
without connector	Thermal current (I _{th}):	10 A	
	Rated insulation voltage (U _i):	500 Vac 600 Vdc	
	Rated impulse withstand voltage (U _{imp}):	400Vac500Vdc(contact blocks 2, 11, 12, 20, 21, 22, 33, 34)	Alternate current: AC15 (50...60 Hz)
		6 kV	Ue (V) 250 400 500
	4 kV (contact blocks 20, 21, 22, 33, 34)	le (A) 6 4 1	
Conditional short circuit current:	1000 A according to EN 60947-5-1	Direct current: DC13	
Protection against short circuits:	fuse 10 A 500 V type aM	Ue (V) 24 125 250	
Pollution degree:	3	le (A) 6 1,1 0,4	
with 4 poles M12 connector	Thermal current (I _{th}):	4 A	
	Rated insulation voltage (U _i):	250 Vac 300 Vdc	
	Protection against short circuits:	fuse 4 A 500 V type gG	Alternate current: AC15 (50...60 Hz)
	Pollution degree:	3	Ue (V) 24 120 250
			le (A) 4 4 4
		Direct current: DC13	
		Ue (V) 24 125 250	
		le (A) 4 1,1 0,4	
with 8 poles M12 connector	Thermal current (I _{th}):	2 A	
	Rated insulation voltage (U _i):	30 Vac 36 Vdc	
	Protection against short circuits:	fuse 2 A 500 V type gG	Alternate current: AC15 (50...60 Hz)
	Pollution degree:	3	Ue (V) 24
			le (A) 2
		Direct current: DC13	
		Ue (V) 24	
		le (A) 2	

Data type approved by IMQ, CCC and EZU

Rated insulation voltage (Ui): 500 Vac
400 Vac (for contact blocks 2, 11, 12, 20, 21, 22, 33, 34)

Thermal current (Ith): 10 A

Protection against short circuits: fuse 10 A 500 V type aM

Rated impulse withstand voltage (U_{imp}): 6 kV
4 kV (for contact blocks 20, 21, 22, 33, 34)

Protection degree: IP67

MV terminals (screw clamps)

Pollution degree 3

Utilization category: AC15

Operation voltage (Ue): 400 Vac (50 Hz)

Operation current (Ie): 3 A

Forms of the contact element: Za, Zb, Za+Za, Y+Y, X+X, Y+Y+X, Y+Y+Y, Y+X+X

Positive opening of contacts on contact block 5, 6, 7, 9, 11, 13, 14, 16, 18, 20, 21, 22, 33, 34

In conformity with standards: EN 60947-1, EN 60947-5-1+ A1:2009, fundamental requirements of the Low Voltage Directive 2006/95/CE.

Please contact our technical service for the list of approved products.

Data type approved by UL

Utilization categories Q300 (69 VA, 125-250 Vdc)
A600 (720 VA, 120-600 Vac)

Data of the housing type 1, 4X "indoor use only", 12, 13

For all contact blocks except 2 and 3 use 60 or 75 °C copper (Cu) conductor and wire size No. 12-14 AWG. Terminal tightening torque of 7,1 lb in (0,8 Nm).
For contact blocks 2 and 3 use 60 or 75 °C copper (Cu) conductor and wire size No. 14 AWG. Terminal tightening torque of 12 lb in (1,4 Nm).

In conformity with standard: UL 508

Please contact our technical service for the list of approved products.

Adjustable levers

In switches with revolving lever it is possible to adjust the lever with 10° steps for the whole 360° range. The positive movement

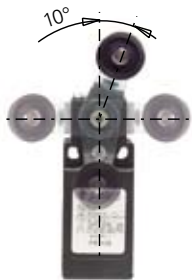

transmission is always guaranteed thanks to the particular geometrical coupling between the lever and the revolving shaft as prescribed for safety applications by the German standard BG-GS-ET-15.

Overturning levers

It's possible to fasten the lever on switches on straight or reverse side, maintaining the positive coupling.

In this way it is possible to obtain two different work plans of the lever.



Rotating heads

In all switches, it is possible to rotate the head in 90° steps.



Working operation of contact block 16 with independent contacts

The contact block 16 has two NC contacts, **both with positive opening** activated independently according to the lever turning direction.

Lever turned to left

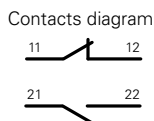

Lever not turned

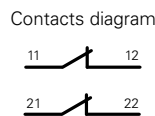

Lever turned to right

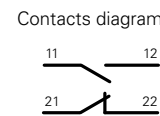



Position switches FR series

Contacts type:

- R** = snap action
- L** = slow action
- LO** = slow action overlapped
- LS** = slow action shifted
- LV** = slow action shifted and spaced
- LI** = slow action independent
- LA** = slow action closer
-  = electronic PNP

Contact blocks

		With external rubber gasket	With stainless steel roller on request	With external rubber gasket With stainless steel roller on request
5	R FR 501	1NO+1NC	FR 5A1	1NO+1NC
6	L FR 601	1NO+1NC	FR 6A1	1NO+1NC
7	LO FR 701	1NO+1NC	FR 7A1	1NO+1NC
9	L FR 901	2NC	FR 9A1	2NC
10	L FR 1001	2NO	FR 10A1	2NO
11	R FR 1101	2NC	FR 11A1	2NC
12	R FR 1201	2NO	FR 12A1	2NO
13	LV FR 1301	2NC	FR 13A1	2NC
14	LS FR 1401	2NC	FR 14A1	2NC
15	LS FR 1501	2NO	FR 15A1	2NO
18	LA FR 1801	1NO+1NC	FR 18A1	1NO+1NC
20	L FR 2001	1NO+2NC	FR 20A1	1NO+2NC
21	L FR 2101	3NC	FR 21A1	3NC
22	L FR 2201	2NO+1NC	FR 22A1	2NO+1NC
2	R FR 201	2x(1NO-1NC)	FR 202	2x(1NO-1NC)
E1	 FR E101	1NO-1NC	FR E1A1	1NO-1NC
Max speed	page 7/5 - type 4		page 7/5 - type 3	
Min. force	8 N (25 N \ominus)		6 N (25 N \ominus)	
Travel diagrams	page 7/6 - group 1		page 7/6 - group 2	

	With external rubber gasket With \varnothing 12 mm stainless steel roller on request	With stainless steel roller on request	With external rubber gasket With stainless steel roller on request	With external rubber gasket With stainless steel roller on request
5	R FR 5A4	1NO+1NC	FR 505	1NO+1NC
6	L FR 6A4	1NO+1NC	FR 605	1NO+1NC
7	LO FR 7A4	1NO+1NC	FR 705	1NO+1NC
9	L FR 9A4	2NC	FR 905	2NC
10	L FR 10A4	2NO	FR 1005	2NO
11	R FR 11A4	2NC	FR 1105	2NC
12	R FR 12A4	2NO	FR 1205	2NO
13	LV FR 13A4	2NC	FR 1305	2NC
14	LS FR 14A4	2NC	FR 1405	2NC
15	LS FR 15A4	2NO	FR 1505	2NO
18	LA FR 18A4	1NO+1NC	FR 1805	1S+1 \bar{O}
20	L FR 20A4	1NO+2NC	FR 2005	1NO+2NC
21	L FR 21A4	3NC	FR 2105	3NC
22	L FR 22A4	2NO+1NC	FR 2205	2NO+1NC
2	R FR 205	2x(1NO-1NC)	FR 2A5	2x(1NO-1NC)
E1	 FR E1A4	1NO-1NC	FR E105	1NO-1NC
Max speed	page 7/5 - type 4		page 7/5 - type 3	
Min. force	6 N (25 N \ominus)		4,3 N (25 N \ominus)	
Travel diagrams	page 7/6 - group 1		page 7/6 - group 2	

Accessories See page 6/1

All measures in the drawings are in mm



Contacts type:	With external rubber gasket	With external rubber gasket	Fixed only by threaded head in vertical position	
<p>R = snap action</p> <p>L = slow action</p> <p>LO = slow action overlapped</p> <p>LS = slow action shifted</p> <p>LV = slow action shifted and spaced</p> <p>LI = slow action independent</p> <p>LA = slow action closer</p> <p>E = electronic PNP</p>				
Contact blocks				
5	R FR 5A7 → 1NO+1NC	FR 508 → 1NO+1NC	FR 510 → 1NO+1NC	FR 512 → 1NO+1NC
6	L FR 6A7 → 1NO+1NC	FR 608 → 1NO+1NC	FR 610 → 1NO+1NC	FR 612 → 1NO+1NC
7	LO FR 7A7 → 1NO+1NC	FR 708 → 1NO+1NC	FR 710 → 1NO+1NC	FR 712 → 1NO+1NC
9	L FR 9A7 → 2NC	FR 908 → 2NC	FR 910 → 2NC	FR 912 → 2NC
10	L FR 10A7 2NO	FR 1008 2NO	FR 1010 2NO	FR 1012 2NO
11	R FR 11A7 → 2NC	FR 1108 → 2NC	FR 1110 → 2NC	FR 1112 → 2NC
12	R FR 12A7 2NO	FR 1208 2NO	FR 1210 2NO	FR 1212 2NO
13	LV FR 13A7 → 2NC	FR 1308 → 2NC	FR 1310 → 2NC	FR 1312 → 2NC
14	LS FR 14A7 → 2NC	FR 1408 → 2NC	FR 1410 → 2NC	FR 1412 → 2NC
15	LS FR 15A7 2NO	FR 1508 2NO	FR 1510 2NO	FR 1512 2NO
18	LA FR 18A7 → 1NO+1NC	FR 1808 → 1NO+1NC	FR 1810 → 1NO+1NC	FR 1812 → 1NO+1NC
20	L FR 20A7 → 1NO+2NC	FR 2008 → 1NO+2NC	FR 2010 → 1NO+2NC	FR 2012 → 1NO+2NC
21	L FR 21A7 → 3NC	FR 2108 → 3NC	FR 2110 → 3NC	FR 2112 → 3NC
22	L FR 22A7 → 2NO+1NC	FR 2208 → 2NO+1NC	FR 2210 → 2NO+1NC	FR 2212 → 2NO+1NC
2	R FR 2A7 2x(1NO-1NC)	FR 208 2x(1NO-1NC)	FR 210 2x(1NO-1NC)	FR 212 2x(1NO-1NC)
E1	E FR E1A7 1NO-1NC	FR E108 1NO-1NC	FR E110 1NO-1NC	FR E112 1NO-1NC
Max speed	page 7/5 - type 3	page 7/5 - type 4	page 7/5 - type 4	page 7/5 - type 4
Min. force	3 N (25 N →)	8 N (25 N →)	8 N (25 N →)	8 N (25 N →)
Travel diagrams	page 7/6 - group 3	page 7/6 - group 1	page 7/6 - group 1	page 7/6 - group 1

Contacts type:	Ø 11 mm polymer roller	Ø 12 mm stainless steel roller		
<p>R = snap action</p> <p>L = slow action</p> <p>LO = slow action overlapped</p> <p>LS = slow action shifted</p> <p>LV = slow action shifted and spaced</p> <p>LI = slow action independent</p> <p>LA = slow action closer</p> <p>E = electronic PNP</p>				
Contact blocks				
5	R FR 513 → 1NO+1NC	FR 514 → 1NO+1NC	FR 515 → 1NO+1NC	FR 515-1 → 1NO+1NC
6	L FR 613 → 1NO+1NC	FR 614 → 1NO+1NC	FR 615 → 1NO+1NC	FR 615-1 → 1NO+1NC
7	LO FR 713 → 1NO+1NC	FR 714 → 1NO+1NC	FR 715 → 1NO+1NC	FR 715-1 → 1NO+1NC
9	L FR 913 → 2NC	FR 914 → 2NC	FR 915 → 2NC	FR 915-1 → 2NC
10	L FR 1013 2NO	FR 1014 2NO	FR 1015 2NO	FR 1015-1 2NO
11	R FR 1113 → 2NC	FR 1114 → 2NC	FR 1115 → 2NC	FR 1115-1 → 2NC
12	R FR 1213 2NO	FR 1214 2NO	FR 1215 2NO	FR 1215-1 2NO
13	LV FR 1313 → 2NC	FR 1314 → 2NC	FR 1315 → 2NC	FR 1315-1 → 2NC
14	LS FR 1413 → 2NC	FR 1414 → 2NC	FR 1415 → 2NC	FR 1415-1 → 2NC
15	LS FR 1513 2NO	FR 1514 2NO	FR 1515 2NO	FR 1515-1 2NO
18	LA FR 1813 → 1NO+1NC	FR 1814 → 1S+1Ö	FR 1815 → 1S+1Ö	FR 1815-1 → 1S+1Ö
20	L FR 2013 → 1NO+2NC	FR 2014 → 1NO+2NC	FR 2015 → 1NO+2NC	FR 2015-1 → 1NO+2NC
21	L FR 2113 → 3NC	FR 2114 → 3NC	FR 2115 → 3NC	FR 2115-1 → 3NC
22	L FR 2213 → 2NO+1NC	FR 2214 → 2NO+1NC	FR 2215 → 2NO+1NC	FR 2215-1 → 2NO+1NC
2	R FR 213 2x(1NO-1NC)	FR 214 2x(1NO-1NC)	FR 215 2x(1NO-1NC)	FR 215-1 2x(1NO-1NC)
E1	E FR E113 1NO-1NC	FR E114 1NO-1NC	FR E115 1NO-1NC	FR E115-1 1NO-1NC
Max speed	page 7/5 - type 2	page 7/5 - type 4	page 7/5 - type 2	page 7/5 - type 2
Min. force	8 N (25 N →)	8 N (25 N →)	8 N (25 N →)	8 N (25 N →)
Travel diagrams	page 7/6 - group 1	page 7/6 - group 1	page 7/6 - group 1	page 7/6 - group 1

Items with code on the green background are available in stock

Contacts type:

- R** = snap action
- L** = slow action
- LO** = slow action overlapped
- LS** = slow action shifted
- LV** = slow action shifted and spaced
- LI** = slow action independent
- LA** = slow action closer
- ⏏** = electronic PNP

Contact blocks

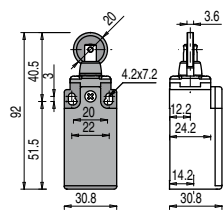

Fixed only by threaded head in vertical position

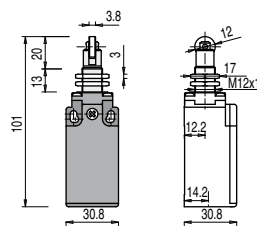

With external rubber gasket

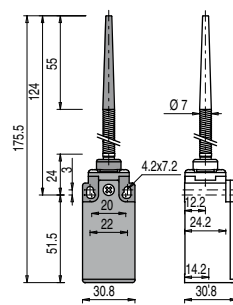

With external rubber gasket

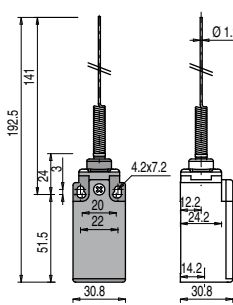

5	R	FR 516	⊕ 1NO+1NC	FR 517	⊕ 1NO+1NC	FR 520	1NO+1NC	FR 521	1NO+1NC
6	L	FR 616	⊕ 1NO+1NC	FR 617	⊕ 1NO+1NC				
7	LO	FR 716	⊕ 1NO+1NC	FR 717	⊕ 1NO+1NC				
9	L	FR 916	⊕ 2NC	FR 917	⊕ 2NC				
10	L	FR 1016	2NO	FR 1017	2NO	FR 1020	2NO	FR 1021	2NO
11	R	FR 1116	⊕ 2NC	FR 1117	⊕ 2NC				
12	R	FR 1216	2NO	FR 1217	2NO	FR 1220	2NO	FR 1221	2NO
13	LV	FR 1316	⊕ 2NC	FR 1317	⊕ 2NC				
14	LS	FR 1416	⊕ 2NC	FR 1417	⊕ 2NC				
15	LS	FR 1516	2NO	FR 1517	2NO				
18	LA	FR 1816	⊕ 1S+1Ö	FR 1817	⊕ 1NO+1NC	FR 1820	1NO+1NC	FR 1821	1NO+1NC
20	L	FR 2016	⊕ 1NO+2NC	FR 2017	⊕ 1NO+2NC	FR 2020	1NO+2NC	FR 2021	1NO+2NC
21	L	FR 2116	⊕ 3NC	FR 2117	⊕ 3NC	FR 2120	3NC	FR 2121	3NC
22	L	FR 2216	⊕ 2NO+1NC	FR 2217	⊕ 2NO+1NC	FR 2220	2NO+1NC	FR 2221	2NO+1NC
2	R	FR 216	2x(1NO-1NC)	FR 217	2x(1NO-1NC)	FR 220	2x(1NO-1NC)	FR 221	2x(1NO-1NC)
E1	⏏	FR E116	1NO-1NC	FR E117	1NO-1NC	FR E120	1NO-1NC	FR E121	1NO-1NC
Max speed		page 7/5 - type 2		page 7/5 - type 2		1 m/s		1 m/s	
Min. force		8 N (25 N ⊕)		8 N (25 N ⊕)		0,07 Nm		0,07 Nm	
Travel diagrams		page 7/6 - group 1		page 7/6 - group 1		page 7/6 - group 4		page 7/6 - group 4	

With external rubber gasket

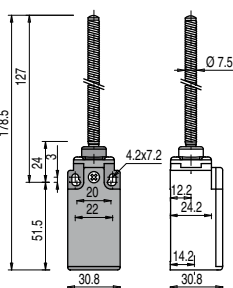

With Ø 20 mm stainless steel roller on request

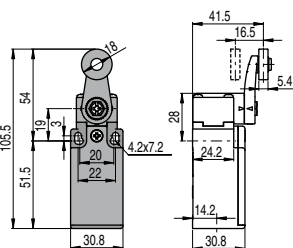

Other rollers available. See page 2/52

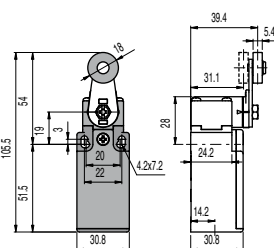

3x3 mm square rod

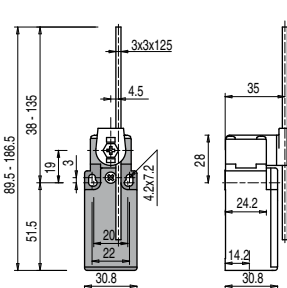

Contact blocks

5	R	FR 525	1NO+1NC	FR 530	⊕ 1NO+1NC	FR 531	⊕ 1NO+1NC	FR 533	1NO+1NC
6	L			FR 630	⊕ 1NO+1NC	FR 631	⊕ 1NO+1NC	FR 633	1NO+1NC
7	LO			FR 730	⊕ 1NO+1NC	FR 731	⊕ 1NO+1NC	FR 733	1NO+1NC
9	L			FR 930	⊕ 2NC	FR 931	⊕ 2NC	FR 933	2NC
10	L	FR 1025	2NO	FR 1030	2NO	FR 1031	2NO	FR 1033	2NO
11	R			FR 1130	⊕ 2NC	FR 1131	⊕ 2NC	FR 1133	2NC
12	R	FR 1225	2NO	FR 1230	2NO	FR 1231	2NO	FR 1233	2NO
13	LV			FR 1330	⊕ 2NC	FR 1331	⊕ 2NC	FR 1333	2NC
14	LS			FR 1430	⊕ 2NC	FR 1431	⊕ 2NC	FR 1433	2NC
15	LS			FR 1530	2NO	FR 1531	2NO	FR 1533	2NO
16	LI			FR 1630	⊕ 2NC	FR 1631	⊕ 2NC	FR 1633	2NC
18	LA	FR 1825	1NO+1NC	FR 1830	⊕ 1NO+1NC	FR 1831	⊕ 1NO+1NC	FR 1833	1S+1Ö
20	L	FR 2025	1NO+2NC	FR 2030	⊕ 1NO+2NC	FR 2031	⊕ 1NO+2NC	FR 2033	1NO+2NC
21	L	FR 2125	3NC	FR 2130	⊕ 3NC	FR 2131	⊕ 3NC	FR 2133	3NC
22	L	FR 2225	2NO+1NC	FR 2230	⊕ 2NO+1NC	FR 2231	⊕ 2NO+1NC	FR 2233	2NO+1NC
2	R	FR 225	2x(1NO-1NC)	FR 230	2x(1NO-1NC)	FR 231	2x(1NO-1NC)	FR 233	2x(1NO-1NC)
E1	⏏	FR E125	1NO-1NC	FR E130	1NO-1NC	FR E131	1NO-1NC	FR E133	1NO-1NC
Max speed		1 m/s		page 7/5 - type 1		page 7/5 - type 1		1,5 m/s	
Min. force		0,12 Nm		0,06 Nm (0,25 Nm ⊕)		0,06 Nm (0,25 Nm ⊕)		0,06 Nm	
Travel diagrams		page 7/6 - group 4		page 7/6 - group 5		page 7/6 - group 5		page 7/6 - group 5	

Accessories See page 6/1



- Contacts type:
- R** = snap action
 - L** = slow action
 - LO** = slow action overlapped
 - LS** = slow action shifted
 - LV** = slow action shifted and spaced
 - LI** = slow action independent
 - LA** = slow action closer
 - A** = electronic PNP

Contact blocks

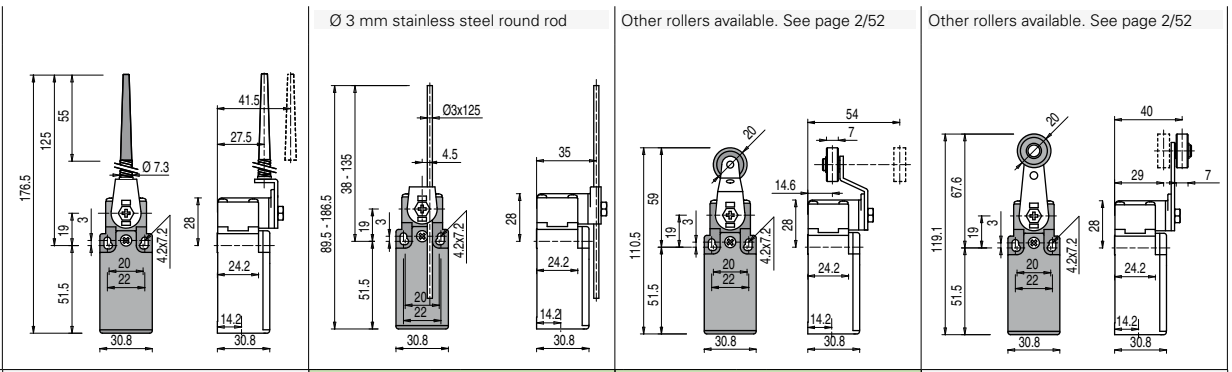

		Ø 3 mm stainless steel round rod	Other rollers available. See page 2/52		Other rollers available. See page 2/52				
5	R	FR 534	1NO+1NC	FR 550	1NO+1NC	FR 551 ⊕	1NO+1NC	FR 552 ⊕	1NO+1NC
6	L	FR 634	1NO+1NC	FR 650	1NO+1NC	FR 651 ⊕	1NO+1NC	FR 652 ⊕	1NO+1NC
7	LO	FR 734	1NO+1NC	FR 750	1NO+1NC	FR 751 ⊕	1NO+1NC	FR 752 ⊕	1NO+1NC
9	L	FR 934	2NC	FR 950	2NC	FR 951 ⊕	2NC	FR 952 ⊕	2NC
10	L	FR 1034	2NO	FR 1050	2NO	FR 1051	2NO	FR 1052	2NO
11	R	FR 1134	2NC	FR 1150	2NC	FR 1151 ⊕	2NC	FR 1152 ⊕	2NC
12	R	FR 1234	2NO	FR 1250	2NO	FR 1251	2NO	FR 1252	2NO
13	LV	FR 1334	2NC	FR 1350	2NC	FR 1351 ⊕	2NC	FR 1352 ⊕	2NC
14	LS	FR 1434	2NC	FR 1450	2NC	FR 1451 ⊕	2NC	FR 1452 ⊕	2NC
15	LS	FR 1534	2NO	FR 1550	2NO	FR 1551	2NO	FR 1552	2NO
16	LI	FR 1634	2NC	FR 1650	2NC	FR 1651 ⊕	2NC	FR 1652 ⊕	2NC
18	LA	FR 1834	1S+1Ö	FR 1850	1S+1Ö	FR 1851 ⊕	1NO+1NC	FR 1852 ⊕	1S+1Ö
20	L	FR 2034	1NO+2NC	FR 2050	1NO+2NC	FR 2051 ⊕	1NO+2NC	FR 2052 ⊕	1NO+2NC
21	L	FR 2134	3NC	FR 2150	3NC	FR 2151 ⊕	3NC	FR 2152 ⊕	3NC
22	L	FR 2234	2NO+1NC	FR 2250	2NO+1NC	FR 2251 ⊕	2NO+1NC	FR 2252 ⊕	2NO+1NC
2	R	FR 234	2x(1NO-1NC)	FR 250	2x(1NO-1NC)	FR 251	2x(1NO-1NC)	FR 252	2x(1NO-1NC)
E1	A	FR E134	1NO-1NC	FR E150	1NO-1NC	FR E151	1NO-1NC	FR E152	1NO-1NC
Max speed		1,5 m/s		1,5 m/s		page 7/5 - type 1		page 7/5 - type 1	
Min. force		0,06 Nm		0,06 Nm		0,06 Nm (0,25 Nm ⊕)		0,06 Nm (0,25 Nm ⊕)	
Travel diagrams		page 7/6 - group 5		page 7/6 - group 5		page 7/6 - group 5		page 7/6 - group 5	

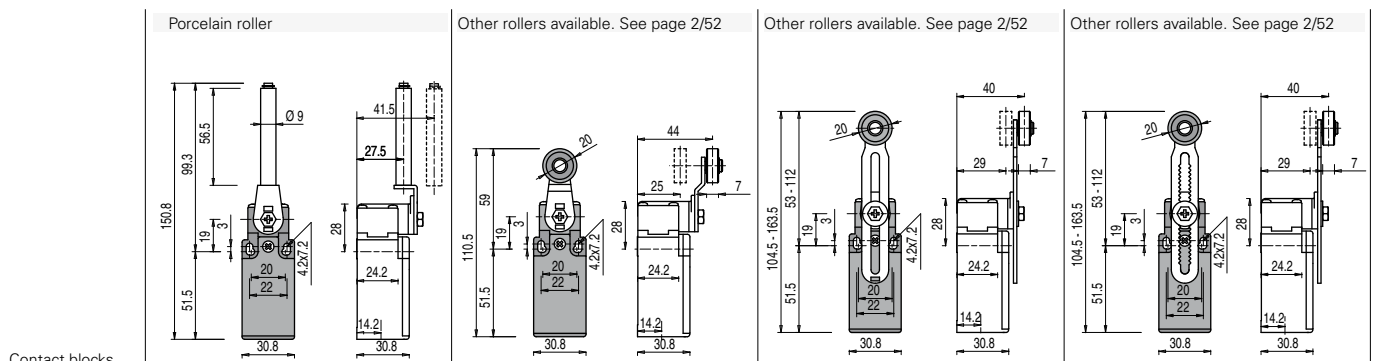

		Porcelain roller	Other rollers available. See page 2/52		Other rollers available. See page 2/52		Other rollers available. See page 2/52		
5	R	FR 553-E0V9	⊕ 1NO+1NC	FR 554	⊕ 1NO+1NC	FR 555 ⊕ (1)	1NO+1NC	FR 556 ⊕	1NO+1NC
6	L	FR 653-E0V9	⊕ 1NO+1NC	FR 654	⊕ 1NO+1NC	FR 655 ⊕ (1)	1NO+1NC	FR 656 ⊕	1NO+1NC
7	LO	FR 753-E0V9	⊕ 1NO+1NC	FR 754	⊕ 1NO+1NC	FR 755 ⊕ (1)	1NO+1NC	FR 756 ⊕	1NO+1NC
9	L	FR 953-E0V9	⊕ 2NC	FR 954	⊕ 2NC	FR 955 ⊕ (1)	2NC	FR 956 ⊕	2NC
10	L	FR 1053-E0V9	2NO	FR 1054	2NO	FR 1055	2NO	FR 1056	2NO
11	R	FR 1253-E0V9	2NO	FR 1154	⊕ 2NC	FR 1155 ⊕ (1)	2NC	FR 1156 ⊕	2NC
12	R	FR 1253-E0V9	2NO	FR 1254	2NO	FR 1255	2NO	FR 1256	2NO
13	LV	FR 1353-E0V9	⊕ 2NC	FR 1354	⊕ 2NC	FR 1355 ⊕ (1)	2NC	FR 1356 ⊕	2NC
14	LS	FR 1453-E0V9	⊕ 2NC	FR 1454	⊕ 2NC	FR 1455 ⊕ (1)	2NC	FR 1456 ⊕	2NC
15	LS	FR 1553-E0V9	2NO	FR 1554	2NO	FR 1555	2NO	FR 1556	2NO
16	LI	FR 1653-E0V9	⊕ 2NC	FR 1654	⊕ 2NC	FR 1655 ⊕ (1)	2NC	FR 1656 ⊕	2NC
18	LA	FR 1853-E0V9	⊕ 1S+1Ö	FR 1854	⊕ 1S+1Ö	FR 1855 ⊕ (1)	1S+1Ö	FR 1856 ⊕	1S+1Ö
20	L	FR 2053-E0V9	⊕ 1NO+2NC	FR 2054	⊕ 1NO+2NC	FR 2055 ⊕ (1)	1NO+2NC	FR 2056 ⊕	1NO+2NC
21	L	FR 2153-E0V9	⊕ 3NC	FR 2154	⊕ 3NC	FR 2155 ⊕ (1)	3NC	FR 2156 ⊕	3NC
22	L	FR 2253-E0V9	⊕ 2NO+1NC	FR 2254	⊕ 2NO+1NC	FR 2255 ⊕ (1)	2NO+1NC	FR 2256 ⊕	2NO+1NC
2	R	FR 253-E0	2x(1NO-1NC)	FR 254	2x(1NO-1NC)	FR 255	2x(1NO-1NC)	FR 256	2x(1NO-1NC)
E1	A	FR E153-E0V9	1NO-1NC	FR E154	1NO-1NC	FR E155	1NO-1NC	FR E156	1NO-1NC
Max speed		0,5 m/s		page 7/5 - type 1		page 7/5 - type 1		page 7/5 - type 1	
Min. force		0,03 Nm (0,25 Nm ⊕)		0,06 Nm (0,25 Nm ⊕)		0,06 Nm (0,25 Nm ⊕)		0,06 Nm (0,25 Nm ⊕)	
Travel diagrams		page 7/6 - group 6		page 7/6 - group 5		page 7/6 - group 5		page 7/6 - group 5	

Items with code on the green background are available in stock

(1) Positive opening only with lever adjusted on the max. See page 2/51. General Catalog 2011-2012



Position switches FR series

Contacts type:

- R** = snap action
- L** = slow action
- LO** = slow action overlapped
- LS** = slow action shifted
- LV** = slow action shifted and spaced
- LI** = slow action independent
- LA** = slow action closer
- E** = electronic PNP

Contact blocks

Other rollers available. See page 2/52

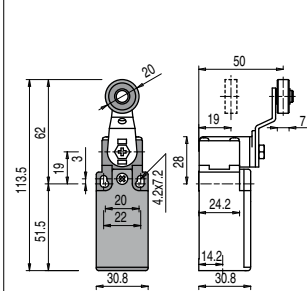

Fiber glass rod

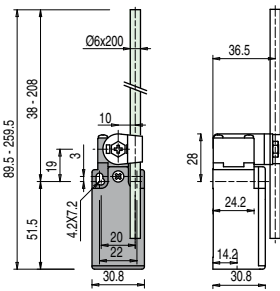

Rope switches for signalling

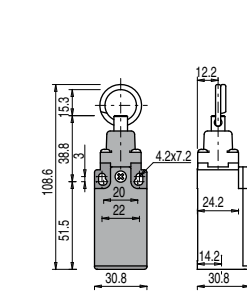

5	R	FR 557	⊕ 1NO+1NC	FR 569	1NO+1NC	FR 576	1NO+1NC
6	L	FR 657	⊕ 1NO+1NC	FR 669	1NO+1NC	FR 676	1NO+1NC
7	LO	FR 757	⊕ 1NO+1NC	FR 769	1NO+1NC	FR 776	1NO+1NC
9	L	FR 957	⊕ 2NC	FR 969	2NC	FR 976	2NO
10	L	FR 1057	2NO	FR 1069	2NO	FR 1076	2NC
11	R	FR 1157	⊕ 2NC	FR 1169	2NC	FR 1176	2NO
12	R	FR 1257	2NO	FR 1269	2NO	FR 1276	2NC
13	LV	FR 1357	⊕ 2NC	FR 1369	2NC	FR 1376	2NO
14	LS	FR 1457	⊕ 2NC	FR 1469	2NC	FR 1476	2NO
15	LS	FR 1557	2NO	FR 1569	2NO	FR 1576	2NC
16	LI	FR 1657	⊕ 2NC	FR 1669	2NC		
18	LA	FR 1857	⊕ 1S+1Ö	FR 1869	1S+1Ö	FR 1876	1NO+1NC
20	L	FR 2057	⊕ 1NO+2NC	FR 2069	1NO+2NC	FR 2076	2NO+1NC
21	L	FR 2157	⊕ 3NC	FR 2169	3NC	FR 2176	3NO
22	L	FR 2257	⊕ 2NO+1NC	FR 2269	2NO+1NC	FR 2276	1NO+2NC
2	R	FR 257	2x(1NO-1NC)	FR 269	2x(1NO-1NC)	FR 276	2x(1NO-1NC)
E1	E	FR E157	1NO-1NC	FR E169	1NO-1NC		
Max speed		page 7/5 - type 1		1,5 m/s		0,5 m/s	
Min. force		0,06 Nm (0,25 Nm ⊕)		0,06 Nm		initial 20 N - final 40 N	
Travel diagrams		page 7/6 - group 5		page 7/6 - group 5		page 7/6 - group 7	

Position switches FR series with reset



Pizzato Eletttrica has developed a reset device code W3 to make perfectly simultaneous the actuator and the contact block tripping. The new device is a block inserted between the switch body and the head, and could be rotated independently from this last one. This new device has following advantages:

- * The reset device integrate in any standard actuation head
- * Contact blocks with snap action are no more necessary because the tripping movement is made by the reset device itself
- * The reset device can be rotated independently from the head for the maximum flexibility during the assembling.

With stainless steel roller on request

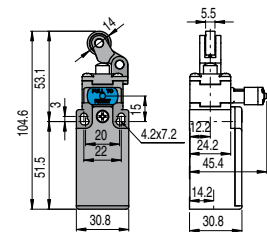

With stainless steel roller on request

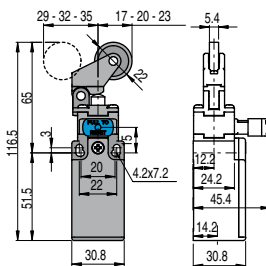
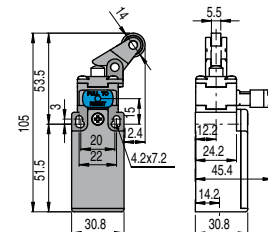

Contact blocks

6	L	FR 601-W3	⊕ 1NO+1NC	FR 602-W3	⊕ 1NO+1NC	FR 605-W3	⊕ 1NO+1NC	FR 607-W3	⊕ 1NO+1NC
9	L	FR 901-W3	⊕ 2NC	FR 902-W3	⊕ 2NC	FR 905-W3	⊕ 2NC	FR 907-W3	⊕ 2NC
10	L	FR 1001-W3	2NO	FR 1002-W3	2NO	FR 1005-W3	2NO	FR 1007-W3	2NO
20	L	FR 2001-W3	⊕ 1NO+2NC	FR 2002-W3	⊕ 1NO+2NC	FR 2005-W3	⊕ 1NO+2NC	FR 2007-W3	⊕ 1NO+2NC
21	L	FR 2101-W3	⊕ 3NC	FR 2102-W3	⊕ 3NC	FR 2105-W3	⊕ 3NC	FR 2107-W3	⊕ 3NC
22	L	FR 2201-W3	⊕ 2NO+1NC	FR 2202-W3	⊕ 2NO+1NC	FR 2205-W3	⊕ 2NO+1NC	FR 2207-W3	⊕ 2NO+1NC
2	R	FR 201-W3	2NO+2NC	FR 202-W3	2NO+2NC	FR 205-W3	2NO+2NC	FR 207-W3	2NO+2NC
Max speed		page 7/5 - type 4		page 7/5 - type 3		page 7/5 - type 3		page 7/5 - type 3	
Min. force		8 N (25 N ⊕)		6 N (25 N ⊕)		6 N (25 N ⊕)		4 N (25 N ⊕)	
Travel diagrams		page 7/7 - group 1		page 7/7 - group 2		page 7/7 - group 2		page 7/7 - group 3	

Accessories See page 6/1

Contacts type:

R = snap action
L = slow action

With stainless steel roller on request

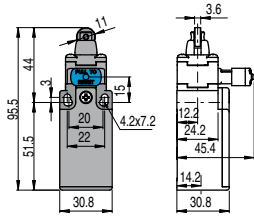

With Ø 20 mm stainless steel roller on request

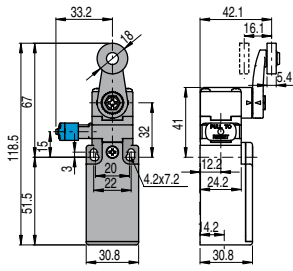

Other rollers available. See page 2/52

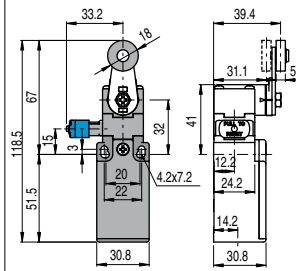

Other rollers available. See page 2/52

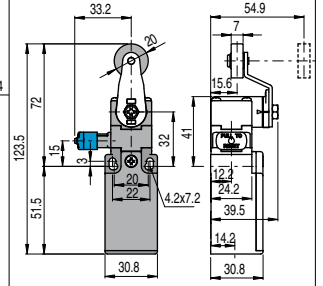

Contact blocks

6	L	FR 615-W3	➔ 1NO+1NC	FR 630-W3	➔ 1NO+1NC	FR 631-W3	➔ 1NO+1NC	FR 651-W3	➔ 1NO+1NC
9	L	FR 915-W3	➔ 2NC	FR 930-W3	➔ 2NC	FR 931-W3	➔ 2NC	FR 951-W3	➔ 2NC
10	L	FR 1015-W3	2NO	FR 1030-W3	2NO	FR 1031-W3	2NO	FR 1051-W3	2NO
20	L	FR 2015-W3	➔ 1NO+2NC	FR 2030-W3	➔ 1NO+2NC	FR 2031-W3	➔ 1NO+2NC	FR 2051-W3	➔ 1NO+2NC
21	L	FR 2115-W3	➔ 3NC	FR 2130-W3	➔ 3NC	FR 2131-W3	➔ 3NC	FR 2151-W3	➔ 3NC
22	L	FR 2215-W3	➔ 2NO+1NC	FR 2230-W3	➔ 2NO+1NC	FR 2231-W3	➔ 2NO+1NC	FR 2251-W3	➔ 2NO+1NC
2	R	FR 215-W3	2NO+2NC	FR 230-W3	2NO+2NC	FR 231-W3	2NO+2NC	FR 251-W3	2NO+2NC
Max speed		page 7/5 - type 2		page 7/5 - type 1		page 7/5 - type 1		page 7/5 - type 1	
Min. force		8 N (25 N ➔)		0,06 Nm (0,25 Nm ➔)		0,06 Nm (0,25 Nm ➔)		0,06 Nm (0,25 Nm ➔)	
Travel diagrams		page 7/7 - group 1		page 7/7 - group 4		page 7/7 - group 4		page 7/7 - group 4	

Other rollers available. See page 2/52

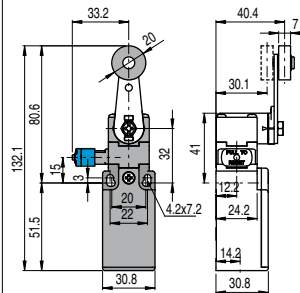

Other rollers available. See page 2/52

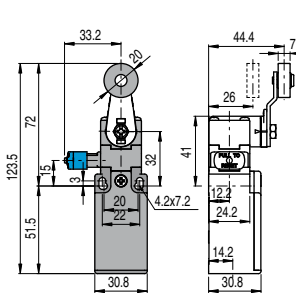

Other rollers available. See page 2/52

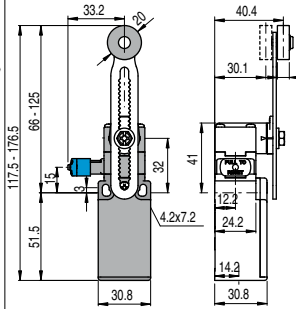

Other rollers available. See page 2/52

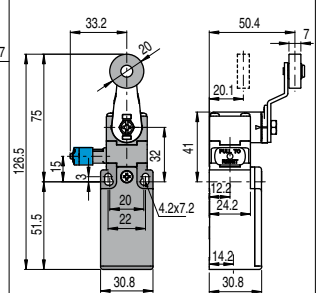

Contact blocks

6	L	FR 652-W3	➔ 1NO+1NC	FR 654-W3	➔ 1NO+1NC	FR 656-W3	➔ 1NO+1NC	FR 657-W3	➔ 1NO+1NC
9	L	FR 952-W3	➔ 2NC	FR 954-W3	➔ 2NC	FR 956-W3	➔ 2NC	FR 957-W3	➔ 2NC
10	L	FR 1052-W3	2NO	FR 1054-W3	2NO	FR 1056-W3	2NO	FR 1057-W3	2NO
20	L	FR 2052-W3	➔ 1NO+2NC	FR 2054-W3	➔ 1NO+2NC	FR 2056-W3	➔ 1NO+2NC	FR 2057-W3	➔ 1NO+2NC
21	L	FR 2152-W3	➔ 3NC	FR 2154-W3	➔ 3NC	FR 2156-W3	➔ 3NC	FR 2157-W3	➔ 3NC
22	L	FR 2252-W3	➔ 2NO+1NC	FR 2254-W3	➔ 2NO+1NC	FR 2256-W3	➔ 2NO+1NC	FR 2257-W3	➔ 2NO+1NC
2	R	FR 252-W3	2NO+2NC	FR 254-W3	2NO+2NC	FR 256-W3	2NO+2NC	FR 257-W3	2NO+2NC
Max speed		page 7/5 - type 1		page 7/5 - type 1		page 7/5 - type 1		page 7/5 - type 1	
Min. force		0,06 Nm (0,25 Nm ➔)		0,06 Nm (0,25 Nm ➔)		0,06 Nm (0,25 Nm ➔)		0,06 Nm (0,25 Nm ➔)	
Travel diagrams		page 7/7 - group 4		page 7/7 - group 4		page 7/7 - group 4		page 7/7 - group 4	

 Items with code on the **green** background are available in stock

Position switches with revolving lever without actuator

Contacts type:

- R** = snap action
- L** = slow action
- LO** = slow action overlapped
- LS** = slow action shifted
- LV** = slow action shifted and spaced
- LI** = slow action independent
- LA** = slow action closer
- ⌘** = electronic PNP

Contact blocks

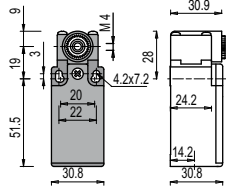

With manual reset knob

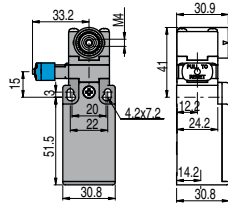

IMPORTANT

For safety applications: join only switches and actuators marked with symbol ⊕. For more information about safety applications see page 7/1.

5	R	FR 538	⊕ 1NO+1NC	
6	L	FR 638	⊕ 1NO+1NC	FR 638-W3 ⊕ 1NO+1NC
7	LO	FR 738	⊕ 1NO+1NC	
9	L	FR 938	⊕ 2NC	FR 938-W3 ⊕ 2NC
10	L	FR 1038	2NO	FR 1038-W3 2NO
11	R	FR 1138	⊕ 2NC	
12	R	FR 1238	2NO	
13	LV	FR 1338	⊕ 2NC	
14	LS	FR 1438	⊕ 2NC	
15	LS	FR 1538	2NO	
16	LI	FR 1638	⊕ 2NC	
18	LA	FR 1838	⊕ 1NO+1NC	
20	L	FR 2038	⊕ 1NO+2NC	FR 2038-W3 ⊕ 1NO+2NC
21	L	FR 2138	⊕ 3NC	FR 2138-W3 ⊕ 3NC
22	L	FR 2238	⊕ 2NO+1NC	FR 2238-W3 ⊕ 2NO+1NC
2	R	FR 238	2x(1NO-1NC)	FR 238-W3 2NO+2NC
E1	⌘	FR E138	1NO-1NC	
Min. force		0,06 Nm (0,25 Nm ⊕)		0,06 Nm (0,25 Nm ⊕)
Travel diagrams		page 7/6 - group 5		page 7/7 - group 4

Loose actuators

IMPORTANT: These loose actuators can be used with items of series FR, FM, FX, FZ, FK only.

Polymer roller Ø 18 mm	Polymer roller Ø 18 mm	Adjustable square rod 3x3x125 mm	Flexible rod actuator	Adjustable round rod Ø 3x125 mm	Polymer roller Ø 20 mm	
VF LE30 ⊕	VF LE31 ⊕	VF LE33	VF LE34	VF LE50	VF LE51 ⊕	
Polymer roller Ø 20 mm	Porcelain roller	Polymer roller Ø 20 mm	Adjustable actuator with polymer roller	Adjustable safety actuator with polymer roller	Polymer roller Ø 20 mm	Adjustable fiber glass rod
VF LE52 ⊕	VF LE53 ⊕ (2)	VF LE54 ⊕	VF LE55 ⊕ (1)	VF LE56 ⊕	VF LE57 ⊕	VF LE69

- Only orders for multiple quantities of the packs are accepted.

(1) Actuator VF LE55 suits to safety applications only if adjusted to its max length, as you can see in figure beside. If you need an adjustable lever for safety applications, use the adjustable safety lever VF LE56.

(2) The position switch obtained by assembling the switch FR •38 (e.g. FR 538, FR 638) with the actuator VF LE53 will not present the same travel diagrams and actuating forces as the position switch FR •53-E0V9 (e.g. FR 553-E0V9, FR 653-E0V9..).

(4) The actuator cannot be oriented to inside direction because it will mechanically interfere with the switch head.

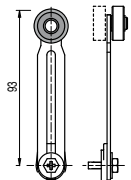

Accessories See page 6/1



Special loose actuators

IMPORTANT: These loose actuators can be used with items of series FR, FM, FX, FZ, FK only.

Ø 20 mm stainless steel rollers

VF LE31-1 (4)	VF LE51-1 (4)	VF LE52-1 (4)	VF LE54-1 (4)	VF LE55-1 (1)	VF LE56-1 (4)	VF LE57-1 (4)

Ø 35 mm polymer rollers

VF LE31-2 (4)	VF LE51-2 (4)	VF LE52-2 (4)	VF LE54-2 (4)	VF LE55-2 (1)	VF LE56-2 (4)	VF LE57-2 (4)

Ø 40 mm rubber rollers

VF LE31-R5 (4)	VF LE51-R5 (4)	VF LE52-R5 (4)	VF LE54-R5 (4)	VF LE55-R5 (1)	VF LE56-R5 (4)	VF LE57-R5 (4)

Ø 50 mm rubber rollers

VF LE51-3 (4)	VF LE52-3 (4)	VF LE54-3 (4)	VF LE55-3 (1)	VF LE56-3 (4)	VF LE57-3 (4)

Ø 50 mm overhanging rubber rollers

VF LE55-4 (1)	VF LE56-4 (4)

Items with code on the green background are available in stock